

SCALE: HORIZ. 1" = 10' VERT. 1" = 4'

NOTE: THE EXISTING SHOULD BE MAINTAINED IN A CONDITION WHICH WILL PREVENT TRACKING OR FLOW OF MUD OFF THE SITE. THIS MAY REQUIRE PERIODIC TOP DRESSING WITH STONE AND REPAIR OR CLEANOUT OF ANY STRUCTURES USED TO TRAP SEDIMENTS.

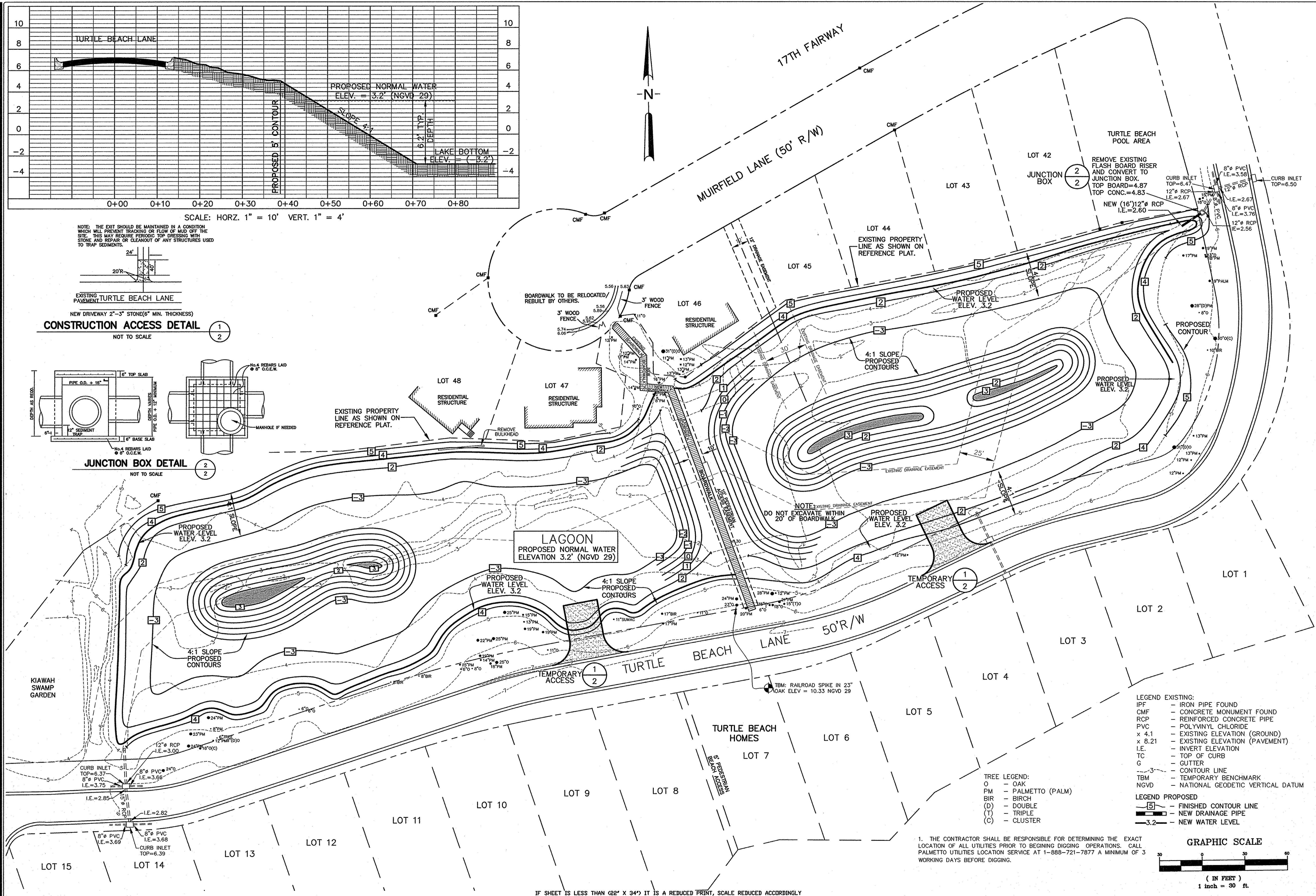
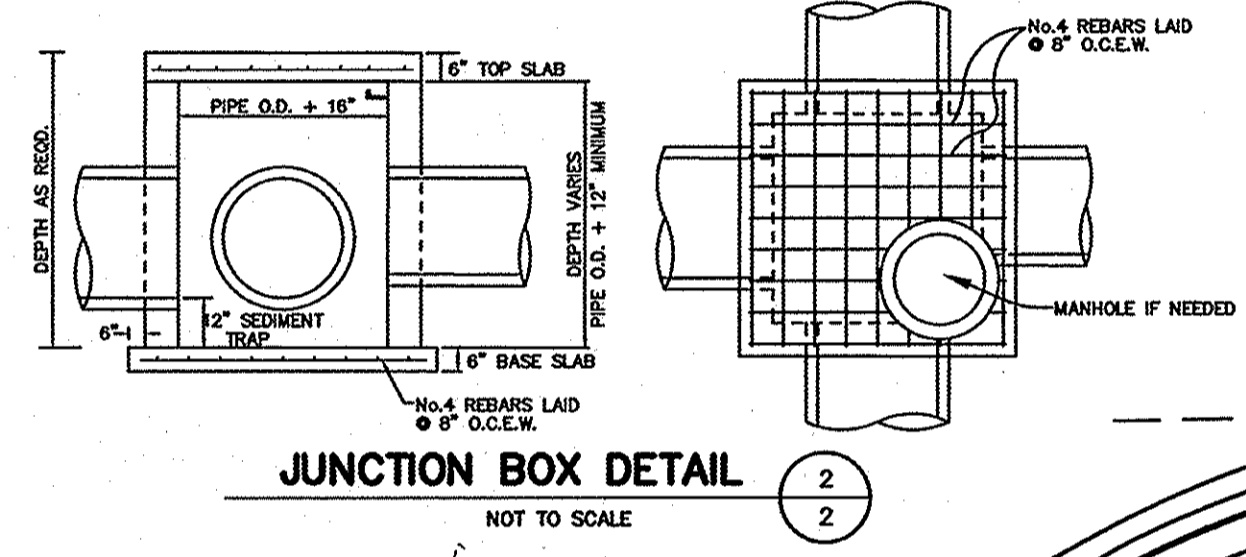
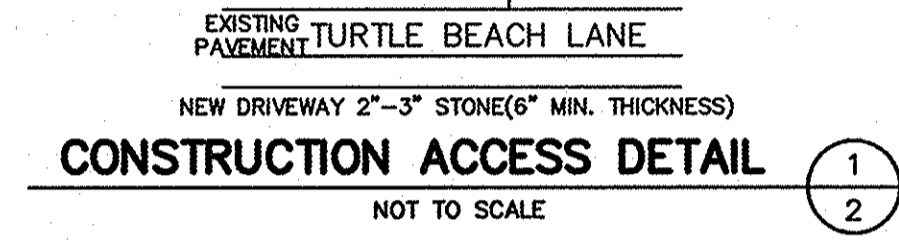
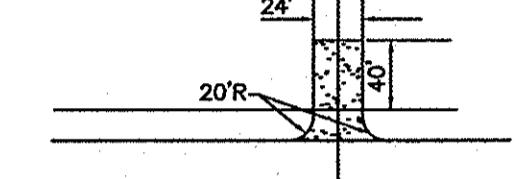

- LEGEND EXISTING:**
- IPF - IRON PIPE FOUND
  - CMF - CONCRETE MONUMENT FOUND
  - RCP - REINFORCED CONCRETE PIPE
  - PVC - POLYVINYL CHLORIDE
  - x 4.1 - EXISTING ELEVATION (GROUND)
  - x 8.21 - EXISTING ELEVATION (PAVEMENT)
  - I.E. - INVERT ELEVATION
  - TC - TOP OF CURB
  - G - GUTTER
  - 3- - CONTOUR LINE
  - TBM - TEMPORARY BENCHMARK
  - NGVD - NATIONAL GEODETIC VERTICAL DATUM
- LEGEND PROPOSED:**
- 5 - FINISHED CONTOUR LINE
  - - - - NEW DRAINAGE PIPE
  - 3.2- - NEW WATER LEVEL

- TREE LEGEND:**
- O - OAK
  - PM - PALMETTO (PALM)
  - BIR - BIRCH
  - (D) - DOUBLE
  - (T) - TRIPLE
  - (C) - CLUSTER

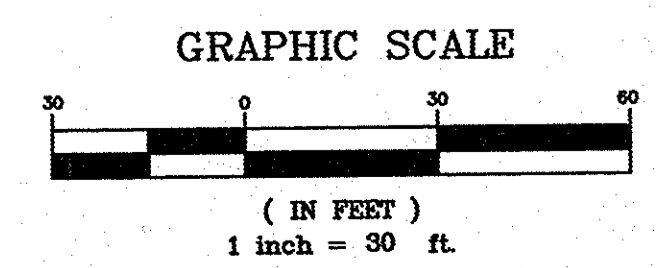

1. THE CONTRACTOR SHALL BE RESPONSIBLE FOR DETERMINING THE EXACT LOCATION OF ALL UTILITIES PRIOR TO BEGINNING DIGGING OPERATIONS. CALL PALMETTO UTILITIES LOCATION SERVICE AT 1-888-721-7877 A MINIMUM OF 3 WORKING DAYS BEFORE DIGGING.

IF SHEET IS LESS THAN (22" X 34") IT IS A REDUCED PRINT, SCALE REDUCED ACCORDINGLY

**FORSBERG ENGINEERING AND SURVEYING, INC.**  
1587 SAVANNAH HIGHWAY SUITE B  
P.O. BOX 30275  
CHARLESTON, SOUTH CAROLINA 29417  
(843) 571-2822 FAX (843) 571-6780  
CIVIL AND LANDSCAPE ARCHITECTURE

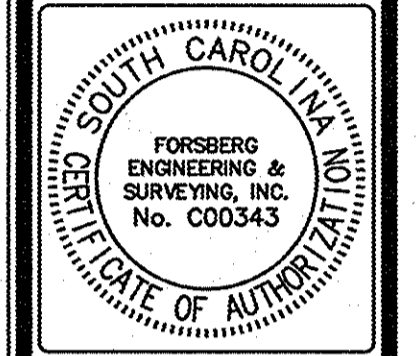
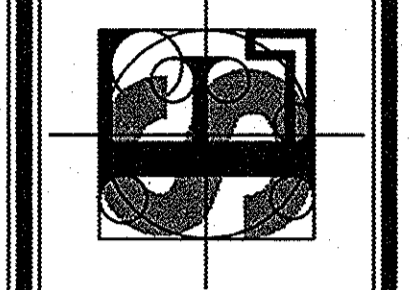

**PROPOSED LAYOUT**  
**TURTLE BEACH HOMES**  
**TURTLE BEACH LANE**  
TOWN OF KIAWAH, CHARLESTON COUNTY, SOUTH CAROLINA

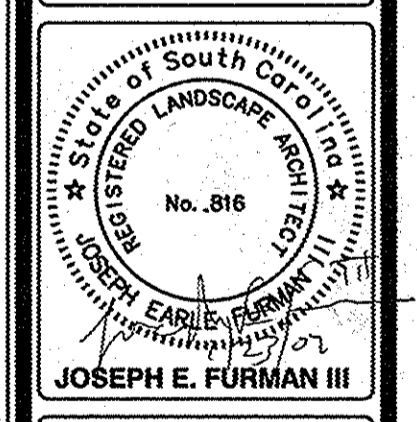

DATE	JANUARY 13, 2005
DRAWN/CHECKED	J.E.F.
LAST REVISED	1/23/05
APPROVED	DCF
SCALE	1" = 30'
PROJECT NO.	3439
SHEET NUMBER	2

OF 2